

# ASA AFF A700 Systems Installation and Setup Instructions

Prepare for installation

1

Install hardware

2

Cable storage

3

Complete system setup  
and configuration

4

## Prepare for installation | Stage 1



Pre-setup

1. Unpack all boxes and inventory contents.

**Attention:** Customers with specific power requirements must check [Hardware Universe](#) for their configuration options.

2. Watch the [Setup Videos](#).

3. Review the [NetApp ONTAP Configuration Guide](#).



Contents  
in the box

Cables in your shipment are order-dependent. Not all cables shown may be in your shipment.

**10 GbE network cable**  
Ethernet, and  
FC network cables



Part number  
X6566B-2 (112-00299), 2m  
X6566B-3 (112-00300), 3m  
X6566B-5 (112-00301), 5m

**40 GbE network cable**  
Ethernet, FC and cluster  
network, HA interconnect



Part number  
X66100-1 (112-00543), 2m  
X66100-3 (112-00544), 3m  
X66100-5 (112-00545), 5m

**MiniSAS HD cable**  
SAS storage cables



Part number  
X-26004-00 (112-00436), 1m  
X-26005-00 (112-00437), 2m  
X-26007-00 (112-00438), 3m

**Additional cables**



**Ethernet cables** **Power cables**

**Cable management arms**

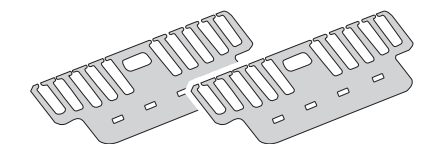

**Slide rail kit**

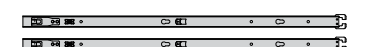

**Note:** For more cable information and part numbers, see the [Hardware Universe](#).

**25 GbE network cable**  
HA interconnect,  
GbE network cable



Part number  
X66240-2 (112-00598), 2m  
X66240-5 (112-00639), 5m

**100 GbE network cable**  
NVMe Storage, Ethernet data  
cable (order dependent)



Part numbers:  
X66211A-1 (112-00573), 1m  
X66211A-2 (112-00574), 2m  
X66211A-5 (112-00576), 5m

**Optical network cable**  
FC networking cables



Part number  
X6553-R6 (112-00188), 2m  
X6536-R6 (112-00090), 5m  
X6554-R6 (112-00189), 15m



You provide

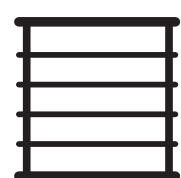

**Rack space**  
8U per chassis



**Screwdriver**  
Phillips #2

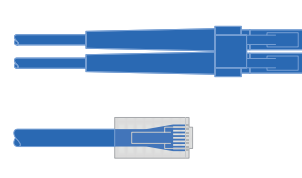

**Additional network cables**  
For connecting your storage system to your network switch and laptop or console.



**Laptop or console**  
With a USB/serial connection and access to a Web browser to configure your storage system

# Install hardware | Stage 2

## 1 Install system in a rack or cabinet:

- Install rail kits, as needed, using the rail kit installation instructions.
- Install the empty chassis into the system cabinet or rack.
- Reinstall the system components into the chassis, matching the chassis slot ID with the slot ID sticker on the component.
- Attach cable management arms.
- Place the bezel on the front of the system.

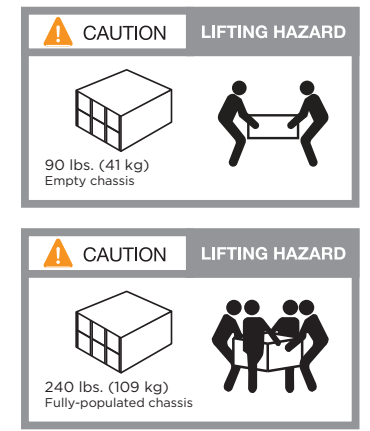
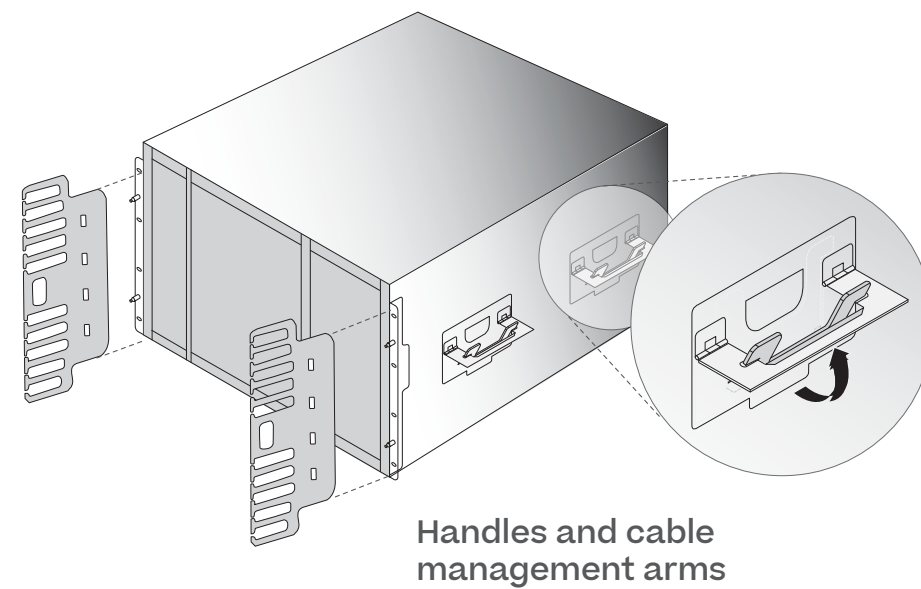

## 2 Cable controller for a switchless cluster:

See your network administrator for help connecting to your switches.

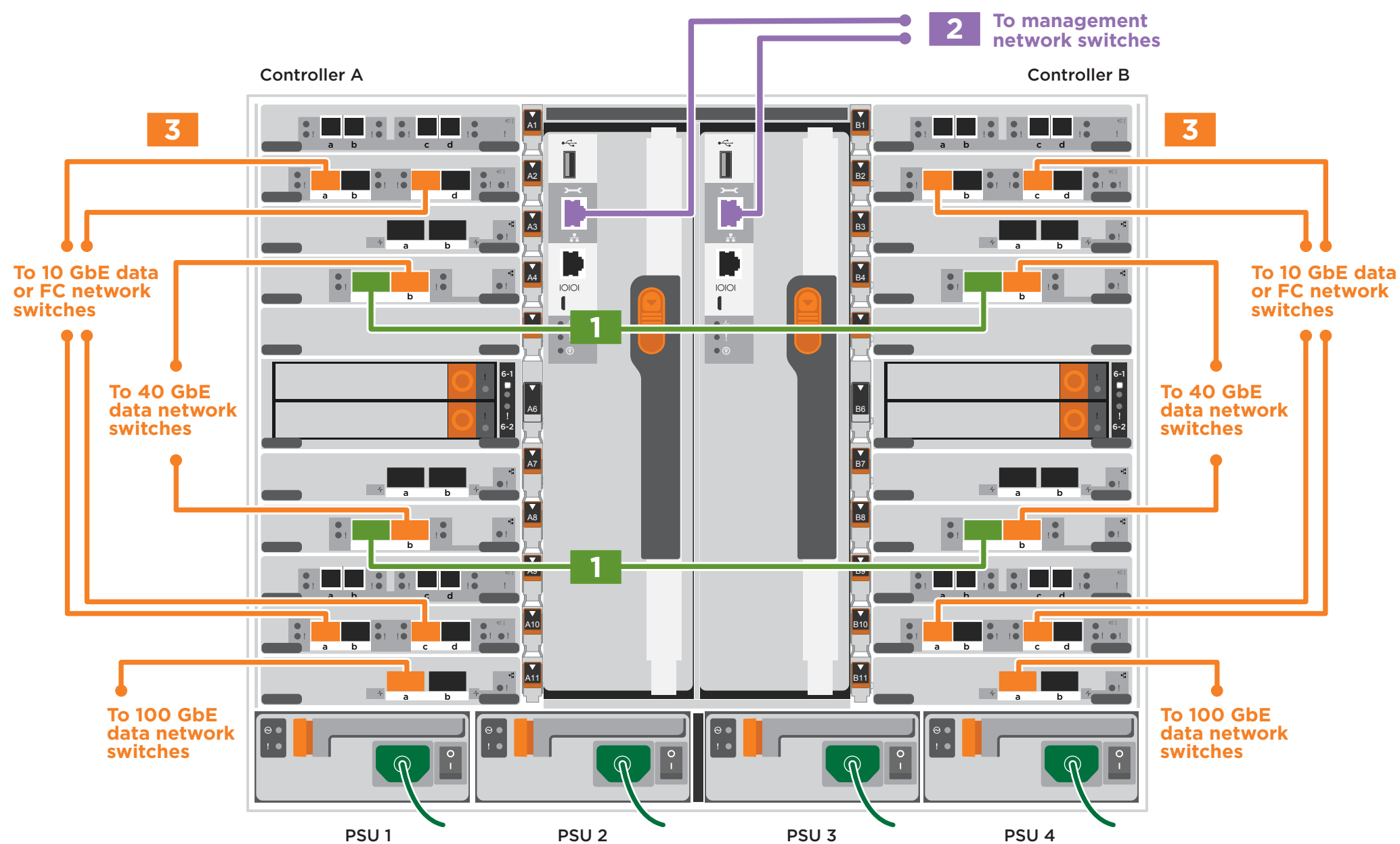

- 1** Cable cluster interconnect ports a together in slot A4 and B4 (e4a) and again in slot A8 and B8 (e8a).

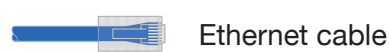

- 2** Connect the wrench ports to the management switches.

**3 On both controllers:**



Connect e2a, e2c, e10a, and e10c to the 10 GbE data or FC switches.



(Order dependent, not shown.)



Connect e4b and e8b to the 40 GbE data switches.



Connect e11a to the 100 GbE data switches.

- 4** Strap the cables to the cable management arms (not shown).



- 5** Connect the power cables to the PSUs and connect them to different power sources.

PSU 1 and PSU 3 provide power to all side A FRUs, PSU 2 and PSU 4 provide power to all side B FRUs.

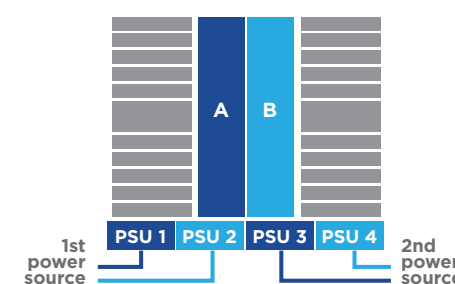

**DO NOT power on controllers at this point.**

# Cable storage | Stage 3

## Cabling an ASA AFF A700 to SAS drive shelves



  Insert SAS cable tab **UP** or tab **DOWN** and gently push into place until it clicks.

- 1** Connect the shelf-to-shelf ports
- 2** Connect controller A to the shelves.
- 3** Connect controller B to the shelves.

———— Multipath HA cabling  
- - - - Quad-path HA cabling (optional)

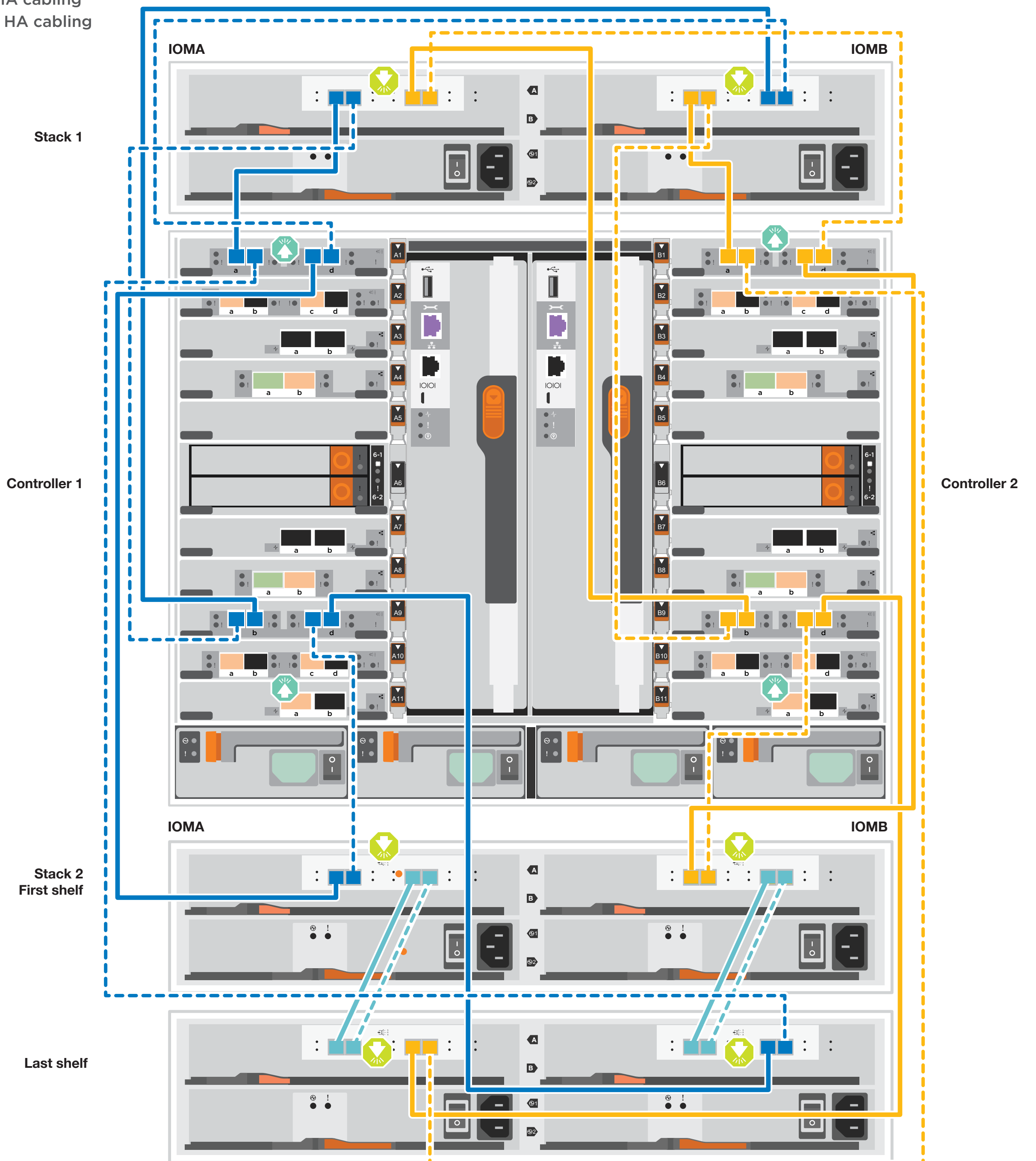

# Cable storage | Stage 3 cont.

## Cabling an ASA AFF A700, running ONTAP 9.8 and later, with one NS224 shelf



 Insert 100 GbE or QSFP28 cable tab **DOWN** and gently push into place until it clicks.

- 1** Connect controller A port e3a to port e0a on NSM A on the shelf.  
Connect controller A port e7b to port e0b on NSM B on the shelf.
- 2** Connect controller B port e3a to port e0a on NSM B on the shelf.  
Connect controller B port e7b to port e0b on NSM A on the shelf.

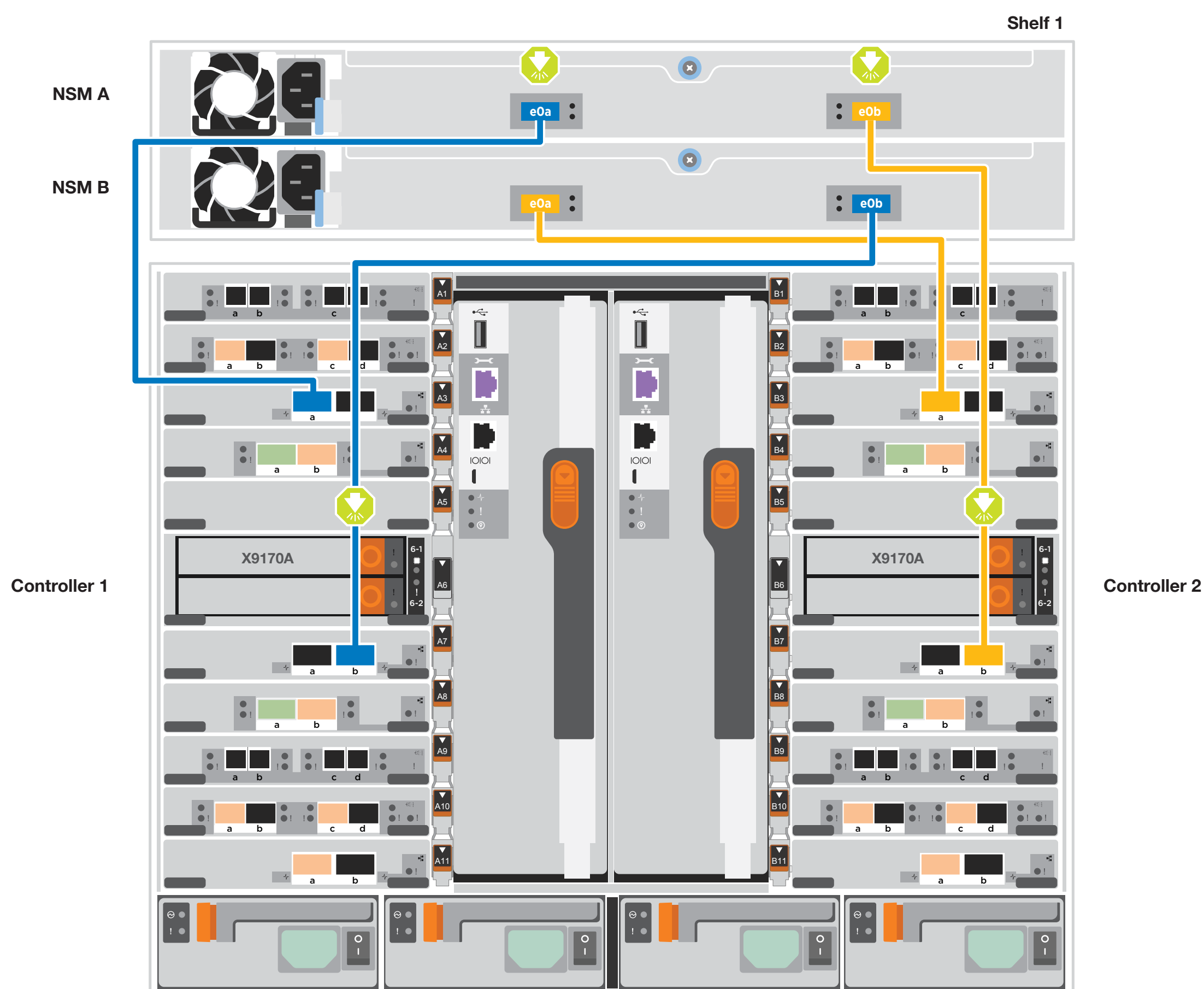

# Cable storage | Stage 3 cont.

## Cabling an ASA AFF A700, running ONTAP 9.8 and later, with two NS224 shelves



Insert 100 GbE or QSFP28 cable tab **DOWN** and gently push into place until it clicks.

Use the table to the right to connect your controllers to the two NS224 shelves.

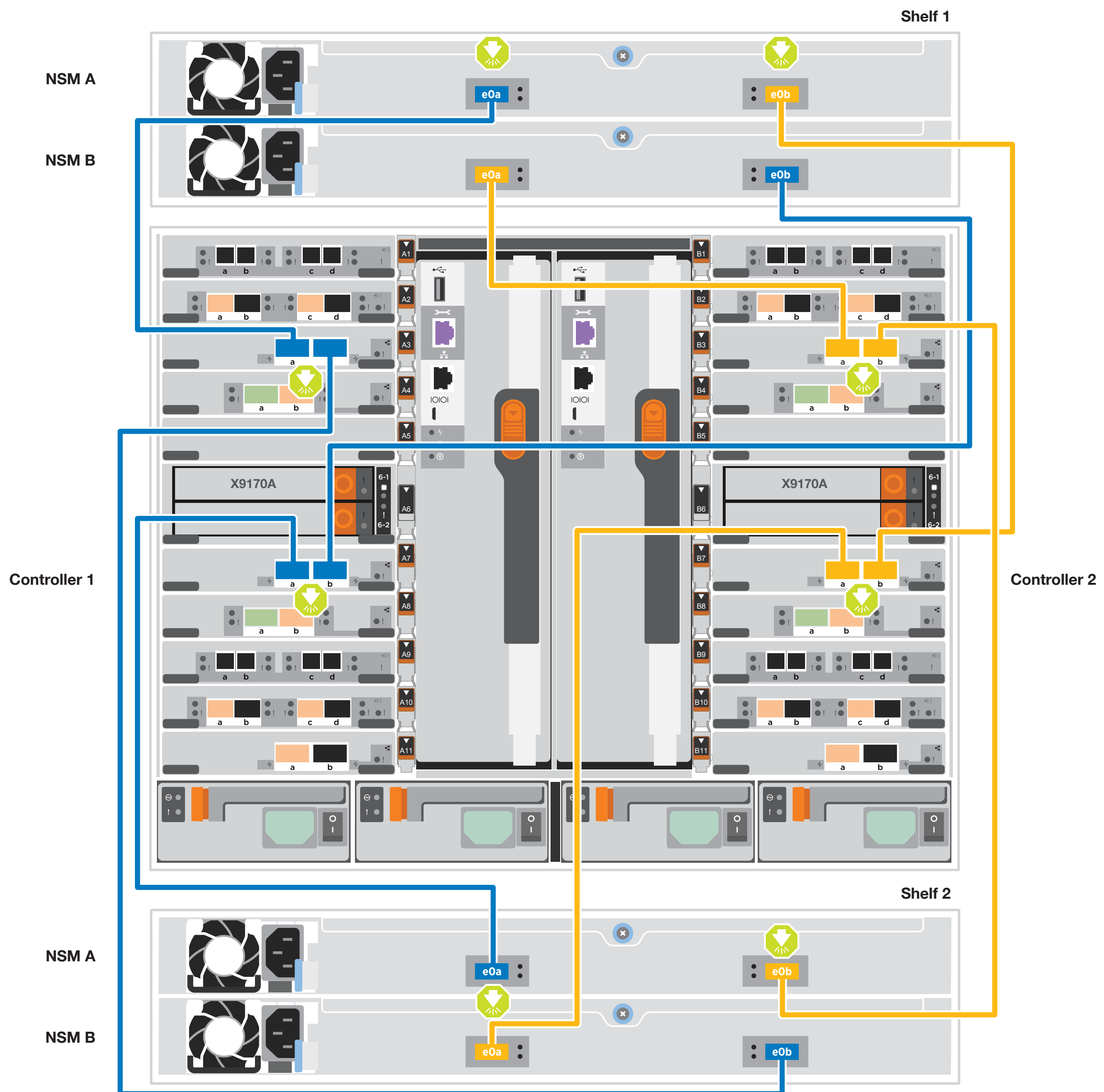
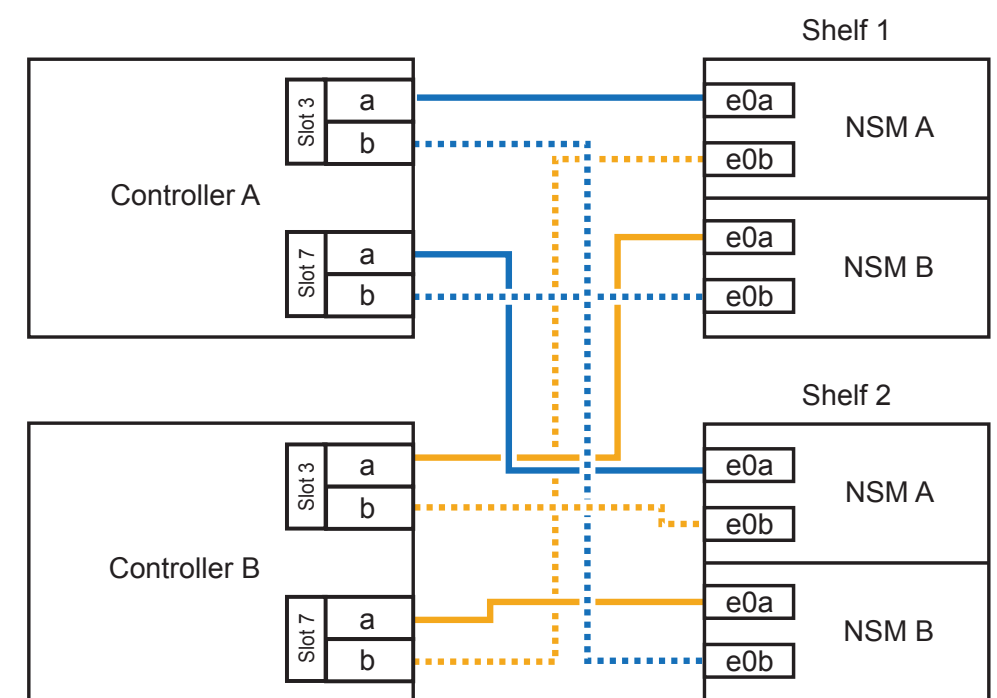



# Complete system setup and configuration | Stage 4

## 1 Power on the shelves and set shelf IDs:

**Note:** For NS224 drive shelves, shelf IDs are pre-set to 00 and 01. If you want to change the shelf IDs, use the straightened end of a paperclip, or narrow tipped ball point pen to access the shelf ID button behind the faceplate.

1. Plug the power cords into the shelf power supplies, and then connect them to power sources on different circuits.

**Note:** NS224 shelves have no power switch and will begin to boot. For all other shelf models, turn on the power switch to boot the shelves.

2. If you need to change the shelf IDs, continue with substeps a through e; otherwise, skip to “Power on the controllers” below.

Repeat these steps for any remaining drive shelves.

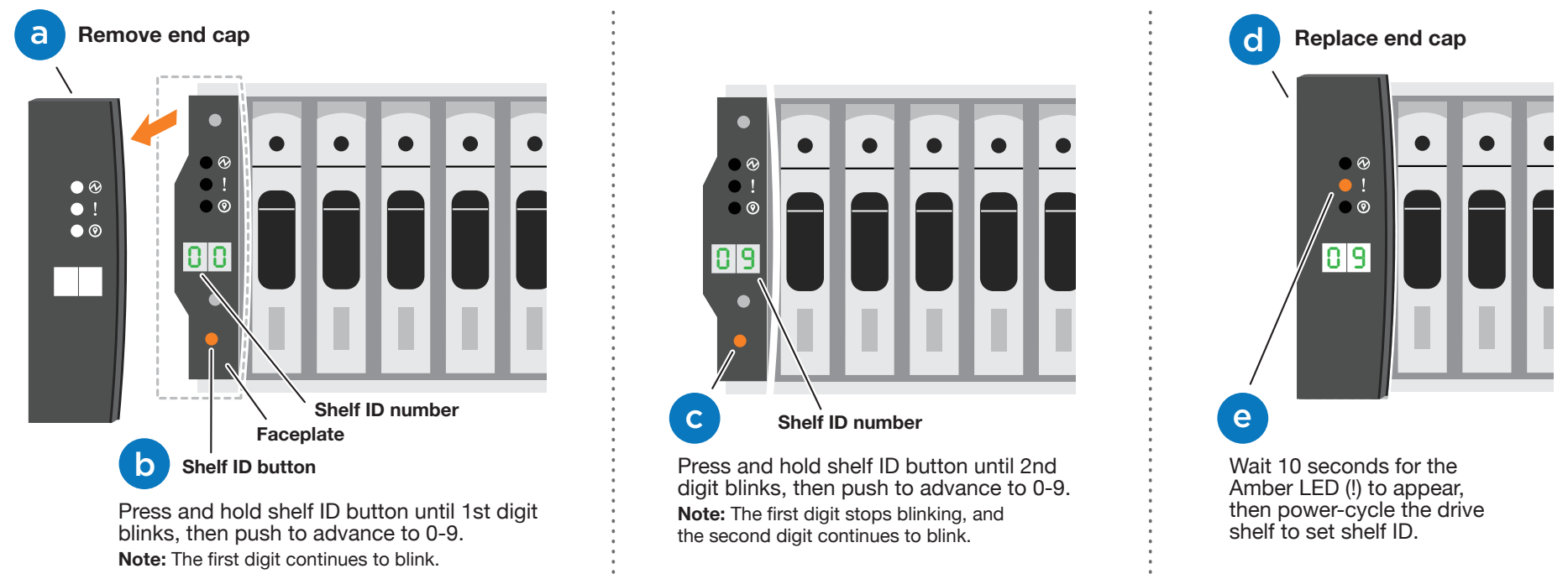

## 2 Turn on the power switches to all nodes:

PSU 1 and PSU 3 provide power to all side A FRUs, PSU 2 and PSU 4 provide power to all side B FRUs.

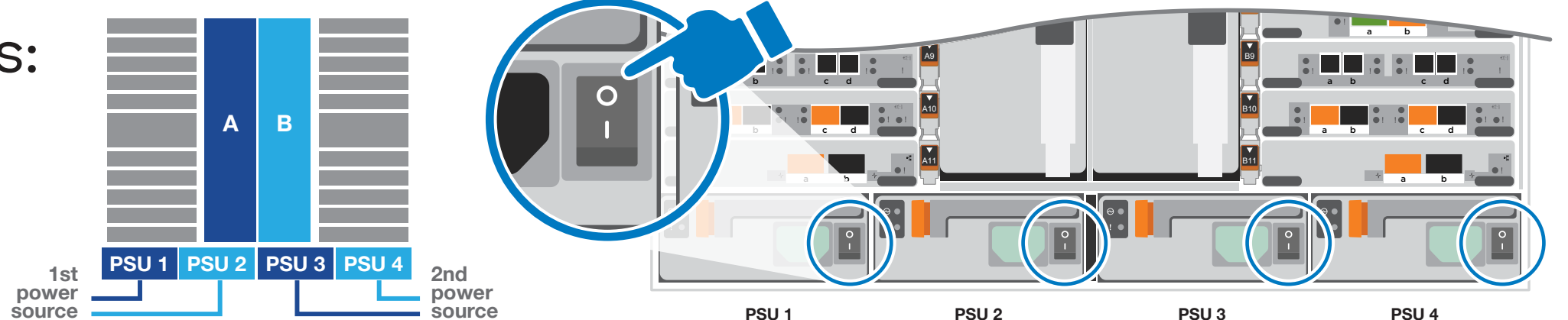

## 3 Complete initial cluster setup with network discovery:

**Note:** If your laptop does not support network discovery, see the [Detailed guide](#).

Connect your laptop to the management switch and access the network computers and devices.

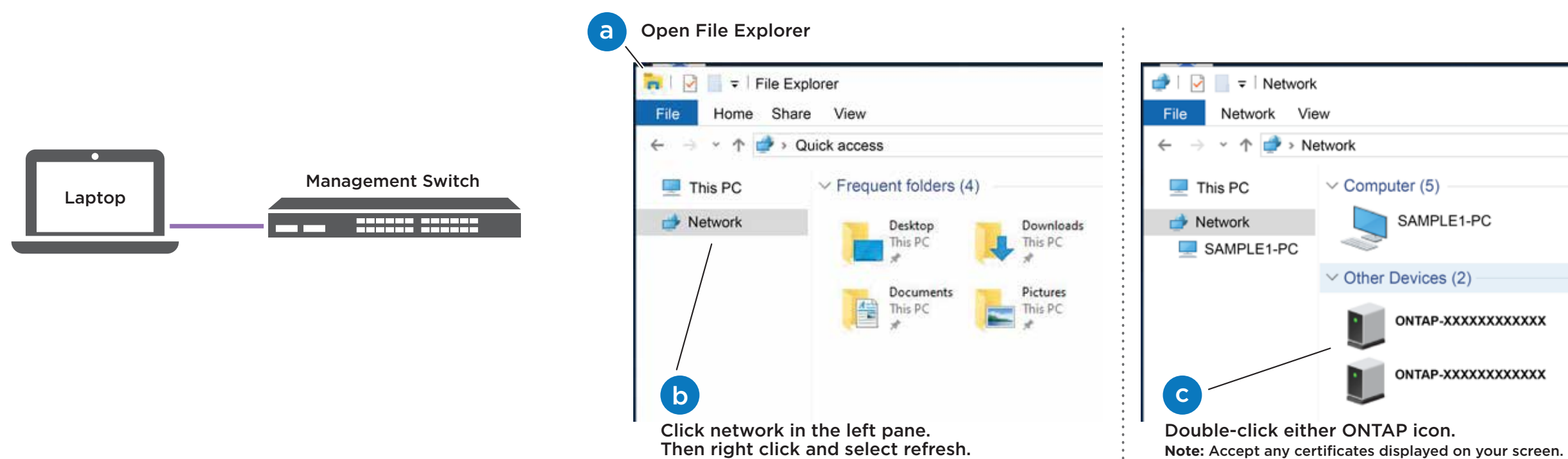

## 4 Use System Manager Guided Setup to configure your cluster.

## 5 Completing setup:

1. Click...
  - a) [mysupport.netapp.com](https://mysupport.netapp.com)
  - b) [Create/log in to your account](#)
  - c) [Download and install Active IQ Config Advisor](#)
  - d) [Register your system](#)
2. Verify the health of your system by running Config Advisor.
3. After you have completed the initial configuration, go to the [NetApp ONTAP Resources](#) page for information about configuring additional features in ONTAP.