



H-Series Hardware

Installing and setting up the H-series storage nodes

September 2020 | 215-14250_2020-09_en-us
doccomments@netapp.com

Contents

Start here: choosing your installation and setup experience.....	3
Installation and setup high-level workflow.....	4
Installation and setup poster.....	8
Installation and setup guide.....	9
Preparing for installation.....	9
Installing the hardware.....	9
Configuring the node.....	11
Creating a new cluster.....	12
Contacting NetApp Support.....	13
Where to find product documentation and other information	14
Copyright and trademark.....	15
Copyright.....	15
Trademark.....	15



Start here: choosing your installation and setup experience

You can choose from different content formats to guide you through the installation and setup of your hardware.

If needed, before you begin the installation and setup of your new system, you can familiarize yourself with the process by reviewing the *Installation and setup high-level workflow*.

[*Installation and setup high-level workflow*](#)

The following content formats are available:

	Installation and setup poster Step-by-step instructions with links to additional content in an easy-to-use visual format. <i>NetApp H-Series Element Storage Nodes Installation and Setup Instructions</i>
	Installation and setup guide Step-by-step instructions in a guide format. <i>Installation and setup guide</i>

Installation and setup high-level workflow

Before you begin the installation and setup of your new system, you can familiarize yourself with the installation process.

H410S installation workflow

The following workflow provides a high-level overview of the installation process for H410S nodes:

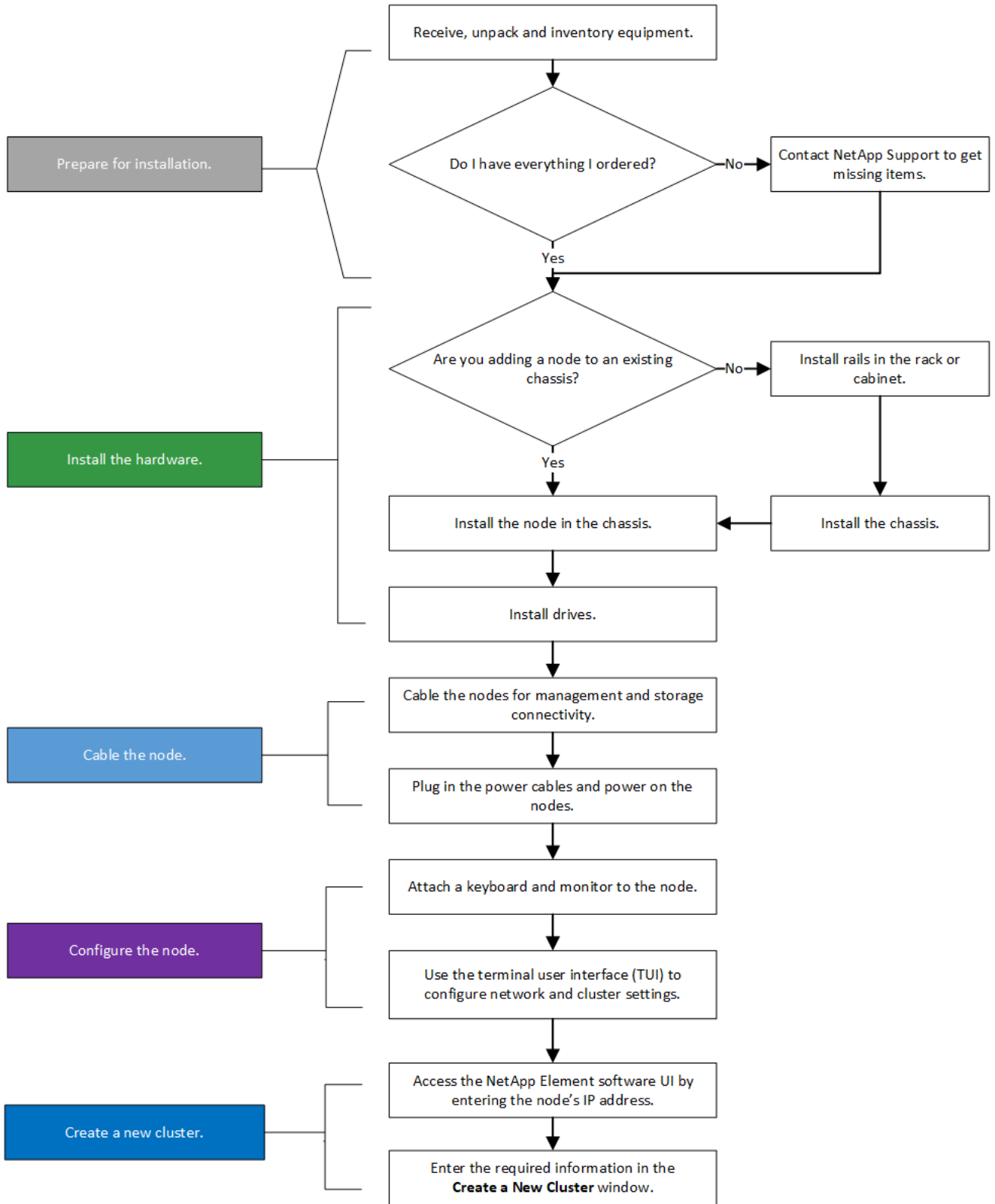

H610S installation workflow

The following workflow provides a high-level overview of the installation process for H610S nodes. The terms "node" and "chassis" are used interchangeably in the case of H610S, because node and chassis are not separate components.

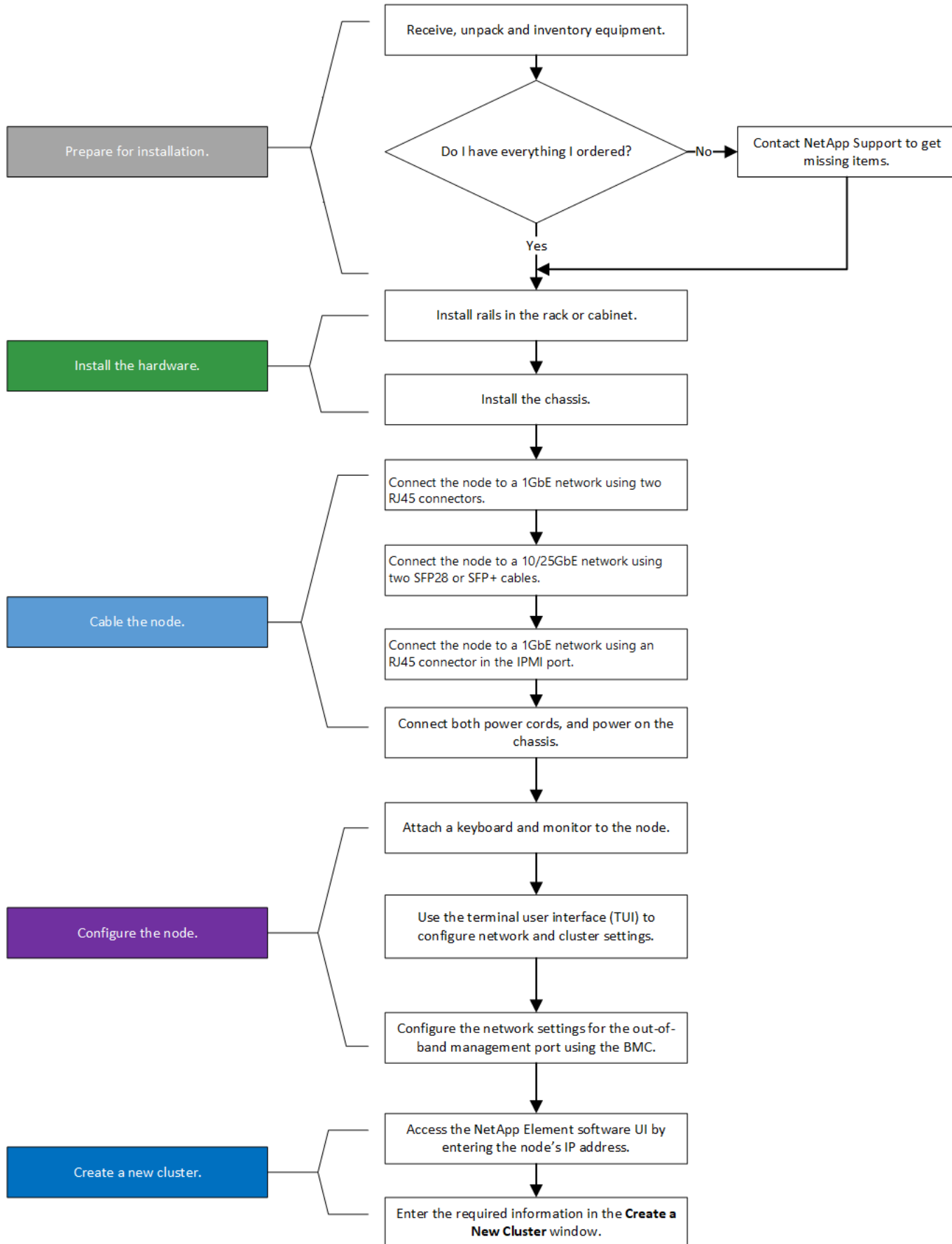

Installation and setup poster

You can use the poster to install and set up your storage nodes. The poster provides step-by-step instructions with links to additional content in an easy-to-use visual format.

[NetApp H-Series Element Storage Nodes Installation and Setup Instructions](#)

Installation and setup guide

You can use this guide to install and set up your new system. You can find step-by-step instructions with links to additional content, and cabling illustrations. The instructions apply to all H-series storage nodes that you can use in your SolidFire all-flash storage installation.

Preparing for installation

Before you install your system, you must inventory the hardware that was shipped to you, and contact NetApp Support if any of the items are missing.

Before you begin

You must provide the following at your site:

- Rack space for the system. You would install an H410S storage node in a two rack unit (2U), four-node chassis. An H610S node (or chassis) needs one rack unit (1U) rack space.
- Cables of the following types:
 - SFP28/SFP+ direct-attach cables or transceivers
 - CAT5e or higher cables with RJ45 connector
- A keyboard, video, mouse (KVM) switch to configure your system
- USB stick (optional)

Steps

1. Unpack the contents of the boxes.
2. Inventory the hardware you received.

If you are setting up a new 2U, four-node installation, the box includes the following hardware:

- Chassis
- Bezel
- Slide rail kit
- Drives
- Nodes
- Power cables (two per chassis)

Note: The hardware that is shipped to you is dependent on what you order. The above list is only an example of what you will find in the box. If you order H610S storage nodes, the drives will come installed in the chassis.

Installing the hardware

You must install your system in a four-post rack or cabinet, as applicable.

About this task

Steps 1 and 2 do not apply if you are adding a new node to an existing two rack unit (2U), four-node chassis.

Steps

1. Install the rails in a four-post rack or cabinet.
[Installing rails for H-Series nodes](#)
2. Install the chassis.



Attention: Use caution while lifting the hardware and installing it into the rack.

- An empty two rack unit (2U), four-node chassis weighs 54.45 lb (24.7 kg) and a node weighs 8.0 lb (3.6 kg).
- An H610S chassis weighs 40.5 lb (18.4 kg).

Note: If you are installing H610S nodes, you can skip steps 3 and 4.

3. Install H410S nodes in the chassis.

The following figure is an example of a chassis with four nodes installed:



4. Install drives.

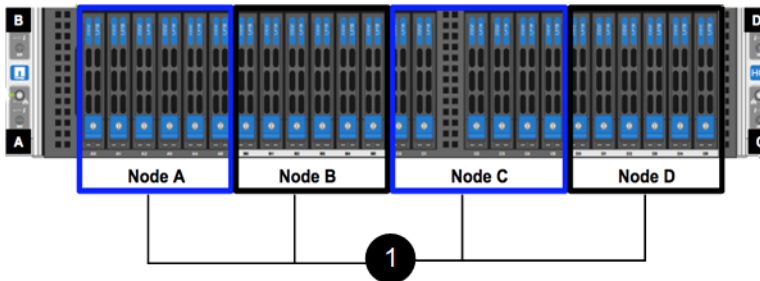

1	Six drives for each storage node in a four-node storage chassis.
----------	------------------------------------------------------------------

5. Cable the storage nodes.



Attention: If the airflow vents at the rear of the chassis are blocked by cables or labels, it can lead to premature component failures due to overheating.

- Cable configuration for H410S storage node:

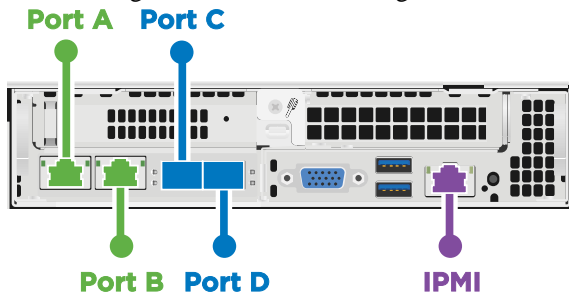

- Connect two CAT5e or higher cables in ports A and B for management connectivity.
 - Connect two SFP28/SFP+ cables or transceivers in ports C and D for storage connectivity.
 - (Optional, recommended) connect a CAT5e cable in the IPMI port for out-of-band management connectivity.
- Cable configuration for H610S storage node:

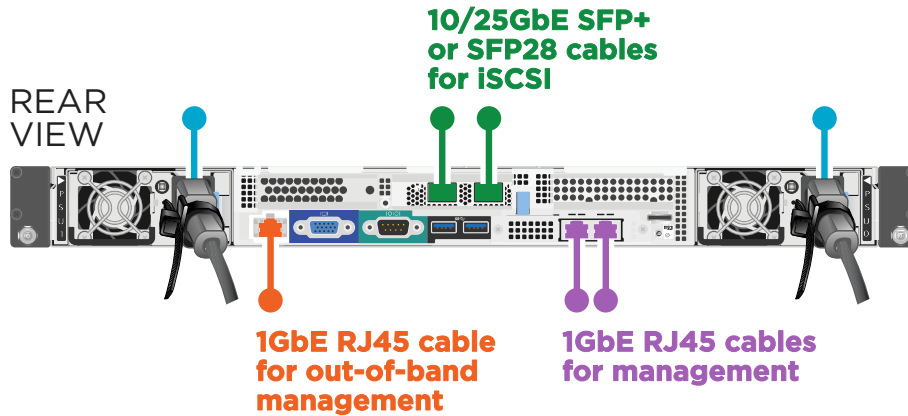

- Connect the node to a 10/25GbE network using two SFP28 or SFP+ cables.
 - Connect the node to a 1GbE network using two RJ45 connectors.
 - Connect the node to a 1GbE network using an RJ-45 connector in the IPMI port.
 - Connect both power cables to the node.
6. Connect the power cords to the two power supply units per chassis and plug them into 240V PDU or power outlet.
- Note:** This step applies only to H410S nodes installed in a 2U, four-node chassis. This step does not apply if you are adding a new node to an existing chassis.
7. Power on the nodes.

- H410S nodes: It takes approximately six minutes for the node to boot.



- H610S nodes: It takes approximately five minutes and 30 seconds for the node to boot.

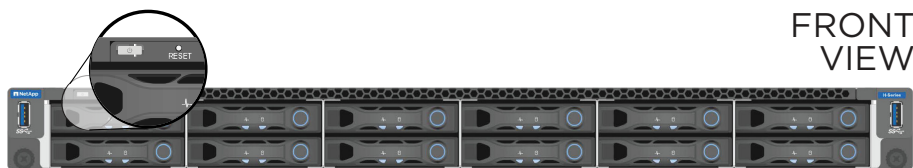

Configuring the node

After you rack and cable the hardware, you are ready to configure your new storage resource.

Before you begin

You have powered on the node.

Steps

1. Attach a keyboard and monitor to the node.
2. In the terminal user interface (TUI) that is displayed, configure the network and cluster settings for the node by using the on-screen navigation.

Note: You must get the IP address of the node from the TUI. You need this when you add the node to a cluster. After you save the settings, the node is in a pending state, and can be

added to a cluster. See the NetApp Element Software Setup Guide for configuration instructions.

Setting up storage with Element software

3. Configure out-of-band management using the Baseboard Management Controller (BMC).

This steps applies only to H610S nodes.

- a. Use a web browser and navigate to the default BMC IP address: 192.168.0.120
- b. Log in using the following default credentials:
 - User name: **root**
 - Password: **calvin**
- c. From the node management screen, navigate to **Settings > Network Settings**, and configure the network parameters for the out-of-band management port.

How to access BMC and change IP address on H610S

Creating a new cluster

After you add the storage node to your installation and configure the new storage resource, you are ready to create a new storage cluster

Steps

1. From a client on the same network as the newly configured node, access the NetApp Element software UI by entering the node's IP address.
2. Enter the required information in the **Create a New Cluster** window.

Setting up storage with Element software

Contacting NetApp Support

If you need help with or have questions or comments about NetApp products, contact NetApp Support.

- Web:
mysupport.netapp.com
- Phone:
 - 888.4.NETAPP (888.463.8277) (US and Canada)
 - 00.800.44.638277 (EMEA/Europe)
 - +800.800.80.800 (Asia/Pacific)

Where to find product documentation and other information

You can learn more about using and managing NetApp HCI and SolidFire all-flash storage from the resources available in the Documentation Centers and Resources pages for both products.

In the Documentation Centers, you can also find information about hardware installation and maintenance, additional content resources available, links to known issues and resolved issues, and the latest release notes. On the Resources pages, you can find links to data sheets, technical reports, white papers, and videos.

- [*NetApp HCI Documentation Center*](#)
- [*NetApp HCI Resources page*](#)
- [*SolidFire and Element 11.3 Documentation Center*](#)
- [*SolidFire Resources page*](#)

Copyright and trademark

Copyright

Copyright © 2020 NetApp, Inc. All rights reserved. Printed in the U.S.

No part of this document covered by copyright may be reproduced in any form or by any means—graphic, electronic, or mechanical, including photocopying, recording, taping, or storage in an electronic retrieval system—without prior written permission of the copyright owner.

Software derived from copyrighted NetApp material is subject to the following license and disclaimer:

THIS SOFTWARE IS PROVIDED BY NETAPP "AS IS" AND WITHOUT ANY EXPRESS OR IMPLIED WARRANTIES, INCLUDING, BUT NOT LIMITED TO, THE IMPLIED WARRANTIES OF MERCHANTABILITY AND FITNESS FOR A PARTICULAR PURPOSE, WHICH ARE HEREBY DISCLAIMED. IN NO EVENT SHALL NETAPP BE LIABLE FOR ANY DIRECT, INDIRECT, INCIDENTAL, SPECIAL, EXEMPLARY, OR CONSEQUENTIAL DAMAGES (INCLUDING, BUT NOT LIMITED TO, PROCUREMENT OF SUBSTITUTE GOODS OR SERVICES; LOSS OF USE, DATA, OR PROFITS; OR BUSINESS INTERRUPTION) HOWEVER CAUSED AND ON ANY THEORY OF LIABILITY, WHETHER IN CONTRACT, STRICT LIABILITY, OR TORT (INCLUDING NEGLIGENCE OR OTHERWISE) ARISING IN ANY WAY OUT OF THE USE OF THIS SOFTWARE, EVEN IF ADVISED OF THE POSSIBILITY OF SUCH DAMAGE.

NetApp reserves the right to change any products described herein at any time, and without notice. NetApp assumes no responsibility or liability arising from the use of products described herein, except as expressly agreed to in writing by NetApp. The use or purchase of this product does not convey a license under any patent rights, trademark rights, or any other intellectual property rights of NetApp.

The product described in this manual may be protected by one or more U.S. patents, foreign patents, or pending applications.

Data contained herein pertains to a commercial item (as defined in FAR 2.101) and is proprietary to NetApp, Inc. The U.S. Government has a non-exclusive, non-transferrable, non-sublicensable, worldwide, limited irrevocable license to use the Data only in connection with and in support of the U.S. Government contract under which the Data was delivered. Except as provided herein, the Data may not be used, disclosed, reproduced, modified, performed, or displayed without the prior written approval of NetApp, Inc. United States Government license rights for the Department of Defense are limited to those rights identified in DFARS clause 252.227-7015(b).

Trademark

NETAPP, the NETAPP logo, and the marks listed on the NetApp Trademarks page are trademarks of NetApp, Inc. Other company and product names may be trademarks of their respective owners.

<http://www.netapp.com/us/legal/netapptmlist.aspx>