



NetApp®

E-Series Systems

DC Power Installation and AC-to-DC Power Conversion Guide

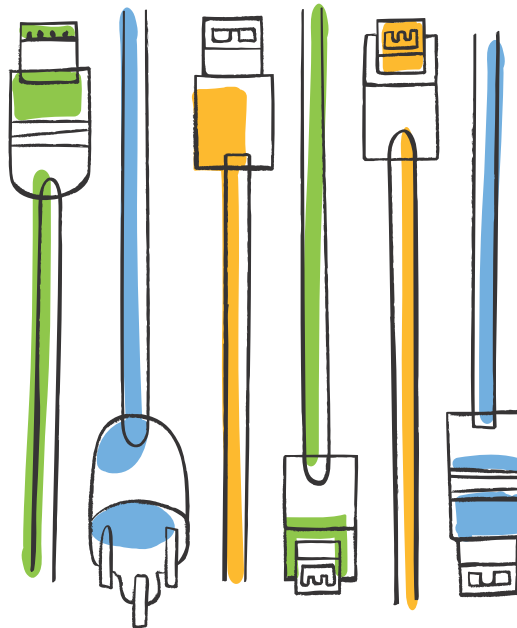

Table of Contents

Deciding whether to use this guide.....	1
How to send your comments.....	2
DC Power Supplies.....	3
DC Power Source Precautions.....	3
Installing a Controller-Drive Tray or a Drive Tray with the DC Power Option.....	4
Connecting the DC Power Cords.....	4
AC-to-DC Power Supply Conversion.....	6
Conversion Kit Contents.....	6
Preparing to Convert a Tray.....	6
Removing the AC Power-Fan Canisters and Installing the DC Power-Fan Canisters.....	6
Turning on the Power to the Trays.....	8
Checking the Hardware Status.....	8
Removing and Replacing a Failed DC Power-Fan Canister.....	11
Removing a Failed DC Power-Fan Canister.....	11
Installing a New DC Power-Fan Canister.....	13
Regulatory Compliance Statements.....	15
Trademark information.....	17
Copyright information.....	18

Deciding whether to use this guide

This guide includes information about installing a DC power source, converting from an AC to a DC power source, and replacing a failed DC power source. Use this guide to install, convert or replace a DC power source into an industry-standard cabinet.

This guide is based on the following assumptions:

- The tray you are converting is not installed in a rack, and is not in use as part of a storage array.

Where to Find the Latest Information About the Product

You can find information about the latest version of the product, including new features and fixed issues, and a link to the latest documentation at the following address: mysupport.netapp.com.

How to send your comments

You can help us to improve the quality of our documentation by sending us your feedback.

Your feedback is important in helping us to provide the most accurate and high-quality information. If you have suggestions for improving this document, send us your comments by email to doccomments@netapp.com. To help us direct your comments to the correct division, include in the subject line the product name, version, and operating system.

You can also contact us in the following ways:

- NetApp, Inc., 495 East Java Drive, Sunnyvale, CA 94089 U.S.
- Telephone: +1 (408) 822-6000
- Fax: +1 (408) 822-4501
- Support telephone: +1 (888) 463-8277

DC Power Supplies

This document is a supplement for NetApp® storage arrays that can use a DC power source. A DC power source uses a DC input to supply power to DC-powered power-fan canisters. The DC voltage input is –48-Vdc.

This document provides the following information:

- A list of DC power compatible trays
- Installing DC power trays
- Removing and replacing a failed power-fan canister

The following 2U trays can use a DC power supply.

Product Type	Channel Interface
DE1600 drive tray	Serial Attached SCSI (SAS)
DE5600 drive tray	SAS
E2712 controller-drive tray	SAS
E2724 controller-drive tray	SAS
E5512 controller-drive tray	SAS
E5524 controller-drive tray	SAS

Each power-fan canister has one DC power connector. Each tray has two power-fan canisters. Be sure to use a separate power source for each power-fan canister in the drive tray to maintain power redundancy.

DC Power Source Precautions

⚠ WARNING (W14) Risk of bodily injury – A qualified service person is required to make the DC power connection according to NEC and CEC guidelines.

⚠ WARNING (W12) Risk of electrical shock – This unit has more than one power source. To remove all power from the unit, all DC MAINS must be disconnected by removing all power connectors (item 4 below) from the power supplies.

⚠ CAUTION (C05) Electrical grounding hazard – This equipment is designed to permit the connection of the DC supply circuit to the earthing conductor at the equipment.

When a tray uses power from a DC power source, you must take into account these precautions:

- A two-pole 30-amp circuit breaker is required between the DC power source and each DC power-fan canister.
- Before turning off any power switches on a DC-powered tray, you must disconnect all two-pole 30-amp circuit breakers.
- Use a grounding strap to the frame of your cabinet or rack to make sure that there is no voltage build-up on any exterior surface.

Installing a Controller-Drive Tray or a Drive Tray with the DC Power Option

To install your controller-drive tray or drive tray with the DC power option, you must follow the procedures in the hardware installation guide for your tray. When you reach the procedure in that guide for connecting the power cords, use the following procedure to connect the DC power cords rather than the procedure in the document for AC power cords.

Connecting the DC Power Cords

Perform the following steps for each controller-drive tray and drive tray that you are installing.

⚠ CAUTION (C05) Electrical grounding hazard – This equipment is designed to permit the connection of the DC supply circuit to the earthing conductor at the equipment.

NOTE Make sure that you do not turn on the power to the controller-drive tray or the connected drive trays until this documentation instructs you to do so.

NOTE Before turning off any power switches on a DC-powered controller-drive tray or drive tray, you must turn off both two-pole 30-amp circuit breakers for the each tray you are installing.

NOTE A two-pole 30-amp circuit breaker is required between the DC power source and each DC power-fan canister for over-current and short-circuit protection.

1. Turn off both two-pole 30-amp circuit breakers for each tray you are installing.
2. Connect a DC power connector cable to the DC power connector on each power-fan canister in the tray.
3. Have a qualified service person connect the other end of each DC power connector cable to the DC power plant equipment through the 30-amp circuit breaker as follows.

NOTE The three source wires on each DC power connector cable (–48 VDC) connect each power-fan canister to centralized DC power plant equipment, typically through a bus bar located above the cabinet.

- a. Connect the brown –48-VDC supply wire to the negative terminal.
- b. Connect the blue return wire to the positive terminal.

- c. Connect the green and yellow ground wire to the ground terminal.

Figure 1. DC Power Connector Cable and Source Wires

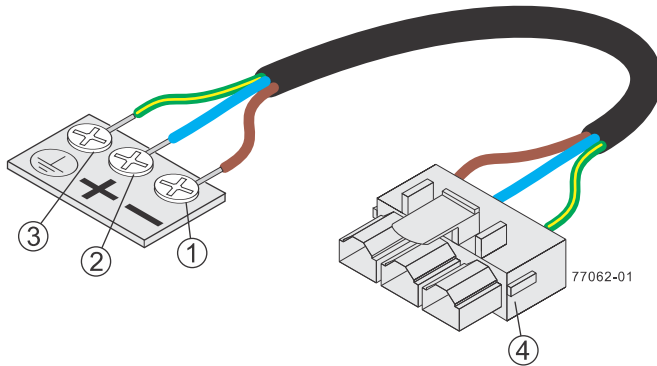

1. Supply (Negative), Brown Wire, -48 VDC
 2. Return (Positive), Blue Wire
 3. Ground, Green and Yellow Wire
 4. DC Power Connector
4. Turn on the two-pole 30-amp DC circuit breaker for each DC power-fan canister in the storage array.
 5. Continue with the steps in the applicable hardware installation guide for Turning on the Power and Checking for Problems.

AC-to-DC Power Supply Conversion

This procedure assumes that the tray you are converting is not installed in a rack and is not in use as part of a storage array.

To convert from an AC power source to a DC power source, perform the following procedures in the order provided.

1. Preparing to convert a tray on page [Preparing to Convert a Tray](#)
2. Removing the AC power-fan canisters and installing the DC power-fan canisters on page [Removing the AC Power-Fan Canisters and Installing the DC Power-Fan Canisters](#)
3. Connecting to the DC power-fan canister to the DC power source on page [Connecting the DC Power Cords](#)
4. Turning on the power to the trays on page [Turning on the Power to the Trays](#)
5. Checking the hardware status on page [Checking the Hardware Status](#)

Contact a Technical Support Representative for information about other types of conversions.

Conversion Kit Contents

The conversion kit contains these items:

- **Two DC power-fan canisters** – To convert your tray from an AC power source to a DC power source.
- **Two DC power cords**
- **Antistatic-protective wrist strap**

Preparing to Convert a Tray

ATTENTION Electrostatic discharge can damage sensitive components – Touching a tray or any of its components without using a proper ground might damage the equipment. To avoid damage, use proper antistatic protection before you handle any component.

1. Put on the supplied antistatic-protective wrist strap, and secure the ground clip to the cabinet or the tray chassis.
2. Gather a replacement power-fan canister.

Removing the AC Power-Fan Canisters and Installing the DC Power-Fan Canisters

⚠ WARNING (W02) Risk of electrical shock – Before removing or installing a power supply, turn off the power switch, and unplug the power cord.

1. Unpack the new DC power-fan canisters from the conversion kit.
 - a. Set them on a dry, level, static-free surface with the top cover side up.
 - b. Save all the packing materials in case you need to return the power-fan canister.

2. Remove the AC power-fan canisters that are in the tray to be converted.

Figure 2. Power-Fan Canister and Controller Canister

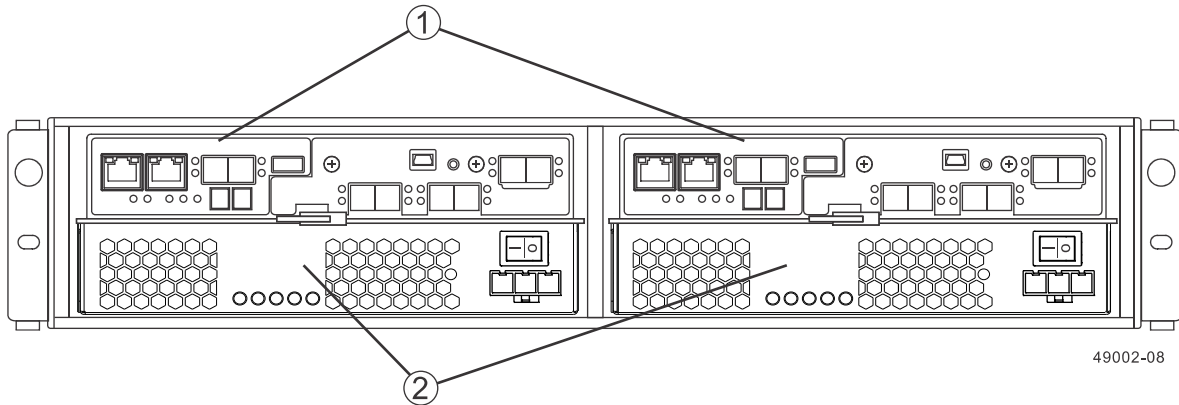

1. Controller Canister
2. Power-Fan Canister
 - a. Unlock and pull out the release levers to release the power-fan canister from the chassis.
 - b. Using the release levers, pull the power-fan canister from the tray.
3. Install the new DC power-fan canister.
 - a. Slowly push the new power-fan canister into the empty slot until it stops.
The power-fan canister will only be partially installed.
 - b. Rotate the release levers towards the center of the power-fan canister to lock it into place.
The power-fan canister is fully secured when it is flush with the enclosure and the levers lock into place.

Figure 3. Installing a DC Power-Fan Canister

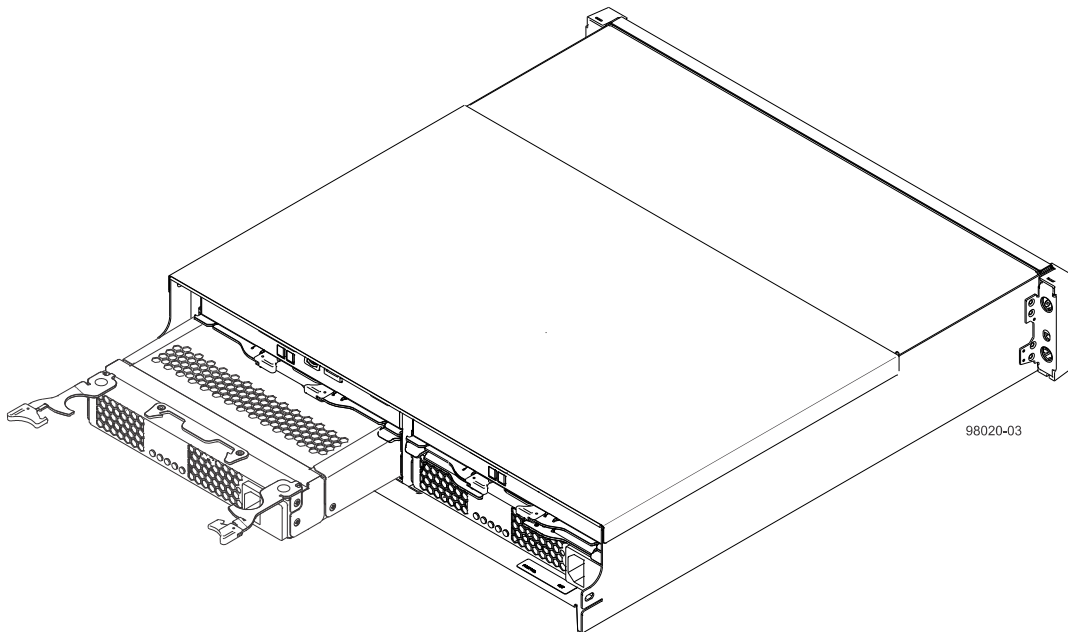

4. Install the tray into the rack. For information about installing the tray, refer to the hardware installation guide.

Turning on the Power to the Trays

1. Turn on the power switch on the rear of each drive tray that is connected to the controller-drive tray.
2. Wait two minutes for the drives to spin up.
3. Turn on the power to both power-fan canisters in the controller-drive tray.

Figure 4. Power Switch on the DC Power-Fan Canister

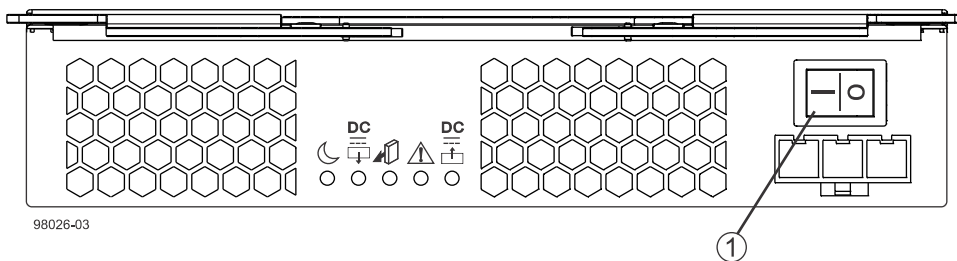

1. Power Switch for the DC Power-Fan Canister
4. Wait three minutes for the power-up process to complete.

Checking the Hardware Status

The LEDs indicate the status of the tray and its components. A green LED indicates a normal operating status. An amber LED indicates a fault. Each time you turn on the power, check the status LEDs on the front and rear of the tray. While the power is being applied, the LEDs blink as the tray and its components complete the power-on process.

For detailed information about the location and status of the LEDs, refer to the installation guide for your particular tray.

1. Wait until the LEDs stop blinking from normal start-up before checking for faults.

Figure 5. LEDs on a DC Power-Fan Canister

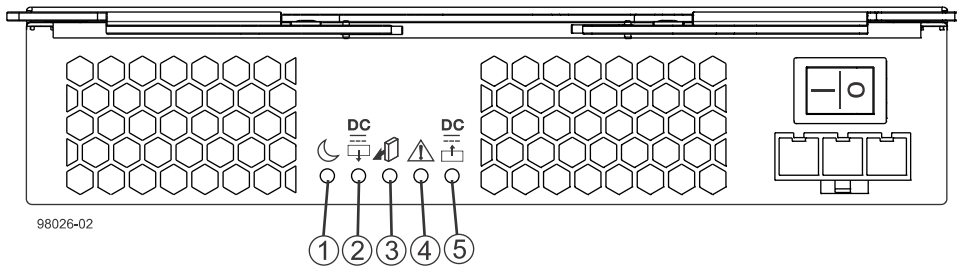

1. Standby Power LED (Green)
 2. Power-Fan Output DC Power LED (Green)
 3. Power-Fan Service Action Allowed LED (Blue)
 4. Power-Fan Service Action Required LED (Amber)
 5. Power-Fan Input DC Power LED (Green)
2. Check the green Input DC Power LED and the amber Power Service Action Required LED on the new power-fan canister.
 3. Based on the LED status, perform one of these actions:
 - **The Input DC Power LED is on, and the Power Service Action Required LED is off** – Go to step [13](#).
 - **The Input DC Power LED is off, or the Power Service Action Required LED is on** – Check that the power-fan canister is installed correctly. Reinstall the power-fan canister. Go to step [4](#).
 4. Did this action correct the problem?
 - **Yes** – Go to step [5](#).
 - **No** – If the problem has not been resolved, contact your Technical Support Representative.
 5. Bring both controllers back online.
 6. To place controller A back online, select **Controller A** and then select **Hardware > Controller > Advanced > Place > Online** and verify that it becomes optimal.
-
- NOTE** This step might take several minutes.
-
7. Verify that controller A has **Optimal** status.
If controller B is not present, go to step [13](#).
 8. If controller B is present, place controller B offline by selecting **Controller B** and then selecting **Hardware > Controller > Advanced > Place > Offline**.
 9. If the Cache Active LED on the controller is illuminated, continue with step [10](#); otherwise skip to step [11](#).
 10. To disable write caching on all volumes, select **Storage > Volume > Change > Cache Settings**. Check the **Select all** option, uncheck **Enable write caching**, and then click **OK**.
 11. To place controller B back online, select **Controller B** and then select **Hardware > Controller > Advanced > Place > Online**.
 12. Verify that controller B has **Optimal** status.
 13. Check the status of all the trays in the storage array.
 14. Does any component have a Needs Attention status?

- **Yes** – Click the **Recovery Guru** toolbar button in the Array Management Window, and complete the recovery procedure. If the problem has not been resolved, contact your Technical Support Representative.
 - **No** – Go to step [15](#).
15. Check the LEDs on the front and the rear of each tray. All of the green LEDs should be on, and all of the amber LEDs should be off. (No LEDs are displayed on empty drive canisters.)
16. Are only the green LEDs on?
- **Yes** – Remove the antistatic-protective wrist strap, and go to step [17](#).
 - **No** – If an amber fault LED is on, a problem exists with the tray. To correct the problem, refer to the documentation for your tray or contact a Technical Support Representative.
17. Gather support data about your updated storage array by using one of these methods:
- Use the storage management software to collect and save a support bundle of your storage array. From the Array Management Window toolbar, select **Monitor > Health > Collect Support Data Manually**. Then either browse or name and specify a location on your system where you want to store the support bundle.
 - Use the CLI to run the `save storageArray supportData` command to gather comprehensive support data about the storage array.

NOTE Gathering data support can temporarily impact performance on your storage array.

For more information about this command, refer to *Command Line Interface and Script Commands Programming Guide*.

Removing and Replacing a Failed DC Power-Fan Canister

Before you replace the power-fan canister, gather antistatic protection and a replacement power-fan canister.

ATTENTION Possible equipment damage – If you perform this procedure with the power turned on, you must complete it within three minutes to prevent the possibility of overheating the equipment.

You can determine whether you have a failed power-fan canister in two ways:

- The Recovery Guru directs you to replace a failed power-fan canister.
- You locate the failed power-fan canister by checking the Power Service Action Required LED.

ATTENTION Possible hardware damage – To prevent electrostatic discharge damage to the tray, use proper antistatic protection when handling tray components.

Figure 6. Power-Fan Canister and Controller Canister

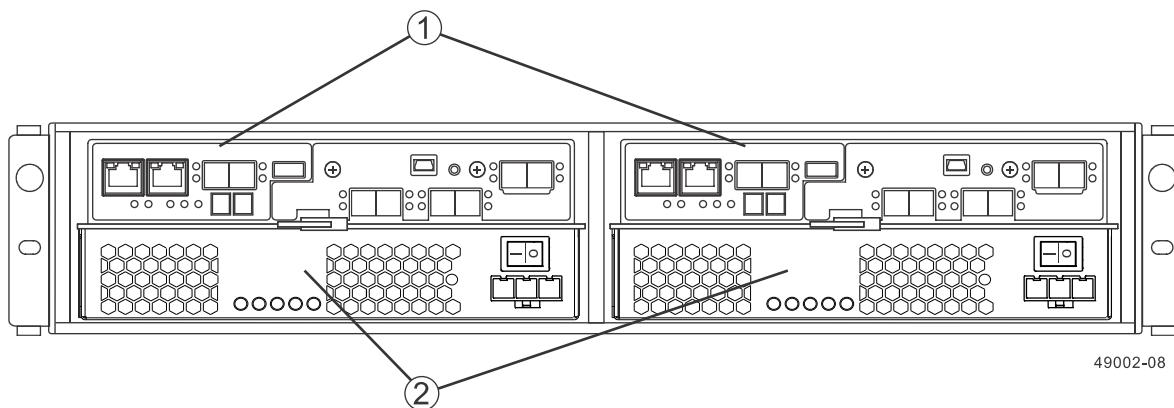

1. Controller Canister
2. Power-Fan Canister

To replace a failed power-fan canister, perform the following procedures in the order provided.

1. Removing a Failed DC Power-Fan Canister on page 4
2. Installing a New DC Power-Fan Canister on page 4

Removing a Failed DC Power-Fan Canister

1. Gather support data about your storage array by using one of these methods:
 - Use the storage management software to collect and save a support bundle of your storage array. From the Array Management Window toolbar, select **Monitor** > **Health** > **Collect Support Data Manually**. Then either browse or name and specify a location on your system where you want to store the support bundle.
 - Use the command line interface (CLI) to run the `save storageArray supportData` command to gather comprehensive support data about the storage array.

NOTE Gathering support data can temporarily impact performance on your storage array.

For more information about this command, refer to the *Command Line Interface and Script Commands Programming Guide*.

2. Did the Recovery Guru direct you to replace a failed power-fan canister?
 - **Yes** – Go to step [4](#).
 - **No** – Run the Recovery Guru to identify the failed component, and go to step [3](#).
3. If the Recovery Guru has directed you to replace the power-fan canister, and the blue Power Service Action Allowed LED is not on, use either the command line or the GUI to prepare the power-fan canister for removal.
 - a. On the command line, type this command and press Enter:
 - SMcli <ctrl_IP1> <ctrl_IP2> -c "Set tray [trayID] [powerfanCanister [left|right] service Allowed Indicator=on;"
 - In this command:
 - <ctrl_IP1> <ctrl_IP2> are the identifiers of the controllers in the controller-drive tray.
 - [trayID] is the identifier of the controller-drive tray or drive tray that contains the power-fan canister you want to replace. Controller-drive tray ID values are 0 to 99. Be sure to type the square brackets around the identifier.
 - [left|right] is the identifier of the power-fan canister you want to replace on the rear of the controller-drive tray. Valid values are left or right. Be sure to type the square brackets around the value.
 - b. On the GUI, click the image of the tray that contains the power-fan canister you want to replace. From the Array Management Window toolbar, select **Hardware > Prepare for Removal**.
4. Put on antistatic protection.
5. Unpack the new power-fan canister.
 - a. Set the new power-fan canister on a flat, static-free surface near the controller-drive tray or drive tray with the top cover up.
 - b. Save all the packing materials in case you need to return the power-fan canister.
6. Check the Power Service Action Required LED to locate the failed power-fan canister.

If a fault is detected, the amber Controller Service Action Required LED is on. If you can safely remove the power-fan canister, the blue Power-Fan Service Action Allowed LED is on.

Figure 7. Power-Fan Canister Service Action LEDs

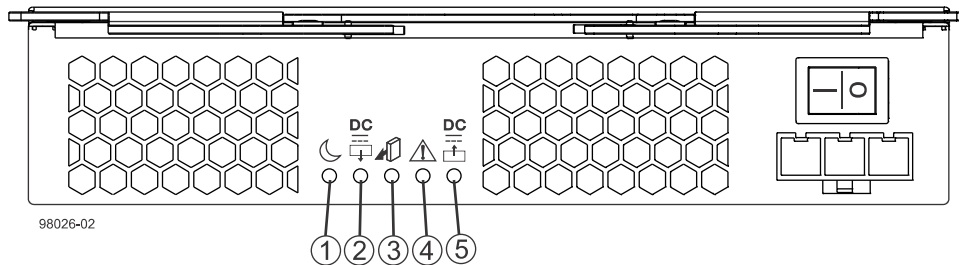

1. Standby Power-Fan LED (Green)
 2. Power-Fan DC Power LED (Green)
 3. Power-Fan Service Action Allowed LED (Blue)
 4. Power-Fan Service Action Required LED (Amber)
 5. Power-Fan DC Power LED (Green)
7. Turn off the 30-amp circuit breaker between the power-fan canister and the DC power source.

- Turn off the Power switch on the power-fan canister that has failed.

Figure 8. Power Switch on the Power-Fan Canister

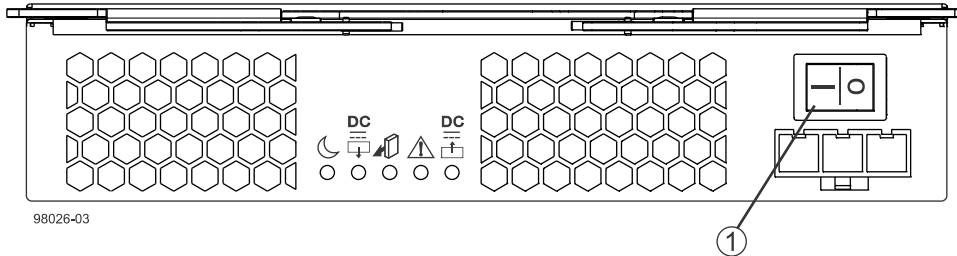

- Power Switch
- Remove the plastic strain relief from the power cord.
 - Unplug the power cord from the failed power-fan canister.
 - Remove the power-fan canister from the controller-drive tray or drive tray.
 - Rotate the power-fan canister latches outward to disengage the power-fan canister.
 - Use the power-fan canister latches as handles to pull the power-fan canister out of the drive tray.While removing the power-fan canister, you might notice an increase in fan speed. The fan speed returns to normal after you have replaced the power-fan canister.

Figure 9. Removing a Power-Fan Canister

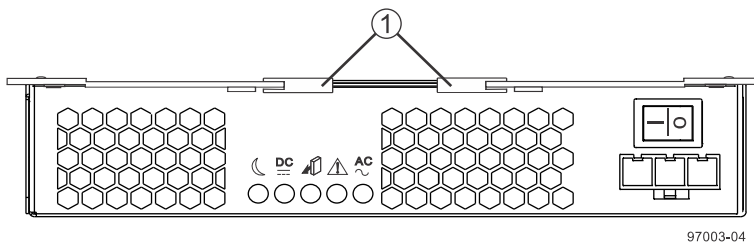

- Power-Fan Canister Latches

Installing a New DC Power-Fan Canister

- Slide the replacement power-fan canister all the way into the controller-drive tray. Rotate the power-fan canister latches towards the center to lock the power-fan canister into place.
- Make sure that the Power switch on the replacement power-fan canister is turned off.
- Plug the DC power cord in to the power-fan canister.
- Attach the plastic strain relief to the power cord, and make sure that it fits snugly up against the power-fan canister.

NOTE A two-pole 30-amp circuit breaker is required between the DC power source and each DC power-fan canister.

- Turn on the Power switch on the replacement power-fan canister.

6. Turn on the 30-amp circuit breaker between the power-fan canister and the DC power source.
7. Check the green Input DC Power LED and the amber Power Service Action Required LED on the new power-fan canister.

Figure 10. Power-Fan Canister Service Action LEDs

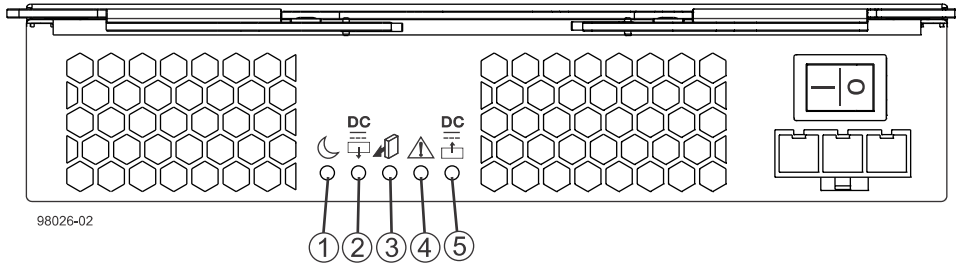

1. Standby Power-Fan LED (Green)
 2. Power-Fan DC Power LED (Green)
 3. Power-Fan Service Action Allowed LED (Blue)
 4. Power-Fan Service Action Required LED (Amber)
 5. Power-Fan AC Power LED (Green)
8. Based on the LED status, perform one of these actions:
 - **The Input DC Power LED is on, and the Power Service Action Required LED is off** – Go to step [11](#).
 - **The Input DC Power LED is off, or the Power Service Action Required LED is on** – Check that the power-fan canister is installed correctly. Reinstall the power-fan canister. Go to step [10](#).
 9. Did this action correct the problem?
 - **Yes** – Go to step [11](#).
 - **No** – If the problem has not been resolved, contact your Technical Support Representative.
 10. Check the status of all of the trays in the storage array.
 11. Does any component have a Needs Attention status?
 - **Yes** – Click the **Recovery Guru** toolbar button in the Array Management Window, and complete the recovery procedure. If the problem has not been resolved, contact your Technical Support Representative.
 - **No** – Go to step [13](#).
 12. Remove the antistatic protection.
 13. Gather support data about your updated storage array by using one of these methods:
 - Use the storage management software to collect and save a support bundle of your storage array. From the Array Management Window toolbar, select **Monitor** > **Health** > **Collect Support Data Manually**. Then either browse or name and specify a location on your system where you want to store the support bundle.
 - Use the CLI to run the `save storageArray supportData` command to gather comprehensive support data about the storage array.

NOTE Gathering support data can temporarily impact performance on your storage array.

For more information about this command, refer to the *Command Line Interface and Script Commands Programming Guide*.

Regulatory Compliance Statements

FCC Radio Frequency Interference Statement

This equipment has been tested and found to comply with the limits for a Class A digital device, pursuant to Part 15 of the Federal Communications Commission (FCC) Rules. These limits are designed to provide reasonable protection against harmful interference in a commercial installation. This equipment generates, uses, and can radiate radio frequency energy and, if not installed and used in accordance with the instructions, may cause harmful interference to radio communications. Operation of this equipment in a residential area is likely to cause harmful interference, in which case the user will be required to correct the interference at his/her own expense.

NetApp, Inc. is not responsible for any radio or television interference caused by unauthorized modification of this equipment or the substitution or attachment of connecting cables and equipment other than those specified by NetApp. It is the user's responsibility to correct interference caused by such unauthorized modification, substitution, or attachment.

Laser Products Statement

This equipment uses Small Form-factor Pluggable (SFP) optical transceivers, which are unmodified Class 1 laser products pursuant to 21 CFR, Subchapter J, Section 1040.10. All optical transceivers used with this product are required to be 21 CFR certified Class 1 laser products. For outside the USA, this equipment has been tested and found compliant with Class 1 laser product requirements contained in European Normalization standard EN 60825 1:2007. Class 1 levels of laser radiation are not considered to be hazardous and are considered safe based upon current medical knowledge. This class includes all lasers or laser systems which cannot emit levels of optical radiation above the exposure limits for the eye under any exposure conditions inherent in the design of the laser products.

NetApp, Inc. is not responsible for any damage or injury caused by unauthorized modification of this equipment or the substitution or attachment of connecting cables and equipment other than those specified by NetApp. It is the user's responsibility to correct interference caused by such unauthorized modification, substitution, or attachment.

This Class A digital apparatus meets all requirements of the Canadian Interference-Causing Equipment Regulations.

Cet appareil numérique de la classé A respecte toutes les exigences du Règlement sur le matériel brouilleur du Canada.

この装置は、第一種情報装置（商工業地域において使用されるべき情報装置）で商工業地域での電波障害防止を目的とした情報処理装置等電波障害自主規制協議会（VCCI）基準に適合しております。

従って、住宅地域またはその隣接した地域で使用すると、ラジオ、テレビジョン受信機等に受信障害を与えることがあります。

取扱説明書に従って正しい取り扱いをして下さい。

**警告使用者： 這是甲類的資訊產品，
在居住的環境中使用時，可能會造成
射頻干擾，在這種情況下，使用者會
被要求採取某些適當的對策。**

Japan Electronics And Information Technology Industries Association (JEITA) Power Cable Statement

同梱された電源コードを他の製品に使用しないで下さい。

Translation of JEITA Power Cable notice.:

Do not use power cord with other products.

NetApp社製品には、NetApp社の納入した電源コードのみ使用できます。

Translation of notice:

Use only NetApp supplied power cords with NetApp equipment.

Compliance with the Spanish Royal Decree 106/2008

Este aviso se proporciona de conformidad con, además de otros requisitos, el Real Decreto español 106/2008: El precio de venta al público de las baterías, los acumuladores y las celdas de potencia incluye el coste de la gestión de su desecho.

Translation of Spanish Royal Decree 106/2008: This notice is provided in accordance with the Royal Decree 106/2008 of Spain: The retail price of batteries, accumulators, and power cells includes the cost of the environmental management of their waste.

Compliance with India E-Waste Rule 2011

This product complies with the India E-waste Rule 2011 and does not contain lead, mercury, hexavalent chromium, polybrominated biphenyls or polybrominated di-phenyl ethers above the maximum concentration value of 0.1% by weight in a homogeneous material and does not contain cadmium above the maximum concentration value of 0.01% by weight in homogeneous material except for the exemptions set in Schedule 2 of the Rule.

Trademark information

NetApp, the NetApp logo, Network Appliance, the Network Appliance logo, Akorri, ApplianceWatch, ASUP, AutoSupport, BalancePoint, BalancePoint Predictor, Bycast, Campaign Express, ComplianceClock, Cryptainer, CryptoShred, CyberSnap, Data Center Fitness, Data ONTAP, DataFabric, DataFort, Decru, Decru DataFort, DenseStak, Engenio, Engenio logo, E-Stack, ExpressPod, FAServer, FastStak, FilerView, Flash Accel, Flash Cache, Flash Pool, FlashRay, FlexCache, FlexClone, FlexPod, FlexScale, FlexShare, FlexSuite, FlexVol, FPolicy, GetSuccessful, gFiler, Go further, faster, Imagine Virtually Anything, Lifetime Key Management, LockVault, Manage ONTAP, Mars, MetroCluster, MultiStore, NearStore, NetCache, NOW (NetApp on the Web), Onaro, OnCommand, ONTAPI, OpenKey, PerformanceStak, RAID-DP, ReplicatorX, SANscreen, SANshare, SANtricity, SecureAdmin, SecureShare, Select, Service Builder, Shadow Tape, Simplicity, Simulate ONTAP, SnapCopy, Snap Creator, SnapDirector, SnapDrive, SnapFilter, SnapIntegrator, SnapLock, SnapManager, SnapMigrator, SnapMirror, SnapMover, SnapProtect, SnapRestore, Snapshot, SnapSuite, SnapValidator, SnapVault, StorageGRID, StoreVault, the StoreVault logo, SyncMirror, Tech OnTap, The evolution of storage, Topio, VelocityStak, vFiler, VFM, Virtual File Manager, VPolicy, WAFL, Web Filer, and XBB are trademarks or registered trademarks of NetApp, Inc. in the United States, other countries, or both.

IBM, the IBM logo, and ibm.com are trademarks or registered trademarks of International Business Machines Corporation in the United States, other countries, or both. A complete and current list of other IBM trademarks is available on the web at <http://www.ibm.com/legal/copytrade.shtml>.

Apple is a registered trademark and QuickTime is a trademark of Apple, Inc. in the United States and/or other countries. Microsoft is a registered trademark and Windows Media is a trademark of Microsoft Corporation in the United States and/or other countries. RealAudio, RealNetworks, RealPlayer, RealSystem, RealText, and RealVideo are registered trademarks and RealMedia, RealProxy, and SureStream are trademarks of RealNetworks, Inc. in the United States and/or other countries.

All other brands or products are trademarks or registered trademarks of their respective holders and should be treated as such.

NetApp, Inc. is a licensee of the CompactFlash and CF Logo trademarks.

NetApp, Inc. NetCache is certified RealSystem compatible.

Copyright information

Copyright © 1994–2014 NetApp, Inc. All rights reserved. Printed in the U.S.

No part of this document covered by copyright may be reproduced in any form or by any means— graphic, electronic, or mechanical, including photocopying, recording, taping, or storage in an electronic retrieval system—without prior written permission of the copyright owner.

Software derived from copyrighted NetApp material is subject to the following license and disclaimer:

THIS SOFTWARE IS PROVIDED BY NETAPP "AS IS" AND WITHOUT ANY EXPRESS OR IMPLIED WARRANTIES, INCLUDING, BUT NOT LIMITED TO, THE IMPLIED WARRANTIES OF MERCHANTABILITY AND FITNESS FOR A PARTICULAR PURPOSE, WHICH ARE HEREBY DISCLAIMED. IN NO EVENT SHALL NETAPP BE LIABLE FOR ANY DIRECT, INDIRECT, INCIDENTAL, SPECIAL, EXEMPLARY, OR CONSEQUENTIAL DAMAGES (INCLUDING, BUT NOT LIMITED TO, PROCUREMENT OF SUBSTITUTE GOODS OR SERVICES; LOSS OF USE, DATA, OR PROFITS; OR BUSINESS INTERRUPTION) HOWEVER CAUSED AND ON ANY THEORY OF LIABILITY, WHETHER IN CONTRACT, STRICT LIABILITY, OR TORT (INCLUDING NEGLIGENCE OR OTHERWISE) ARISING IN ANY WAY OUT OF THE USE OF THIS SOFTWARE, EVEN IF ADVISED OF THE POSSIBILITY OF SUCH DAMAGE.

NetApp reserves the right to change any products described herein at any time, and without notice. NetApp assumes no responsibility or liability arising from the use of products described herein, except as expressly agreed to in writing by NetApp. The use or purchase of this product does not convey a license under any patent rights, trademark rights, or any other intellectual property rights of NetApp.

The product described in this manual may be protected by one or more U.S. patents, foreign patents, or pending applications.

RESTRICTED RIGHTS LEGEND: Use, duplication, or disclosure by the government is subject to restrictions as set forth in subparagraph (c)(1)(ii) of the Rights in Technical Data and Computer Software clause at DFARS 252.277-7103 (October 1988) and FAR 52-227-19 (June 1987).

